



# Fume hood controller

## Type C



The **controller type C** is a safety device allowing **PID** (control loop) regulation of the exhausted air flow.

A speed sensor is used to determine the flow rate. An audible and visual alarm is set off in case of insufficient speed or too high sash height or other conditions.

The HMI (Human Machine Interface) is used to control the fume cupboard ventilation and to carry out the necessary adjustments on site.

This controller complies with EN 14175 and RoHS standards.



## Table of contents

1. Presentation .....	3
1.1. Front panel .....	3
1.2. Electronic panel .....	3
1.3. Schematic diagram .....	4
1.4. Connector specifications .....	5
2. Installation and mounting .....	6
2.1. Dimensions .....	6
2.2. Installation on the fume hood .....	7
2.3. Cutting template .....	8
2.4. Installation tips .....	9
3. Wiring diagram .....	10
4. Adjustment procedure .....	11
5. Factory reset .....	12
6. Test mode .....	12
7. Change the audible alarm delay .....	13
8. Error messages (digital display option) .....	13
9. FAQ .....	14
10. Maintenance .....	15
11. Warranty .....	15





## 1. Presentation

The **type C** airflow controller is an electronic unit that can be easily installed on all fume hood. The front panel controls the ventilation while the rear panel provides wiring

### 1.1. Front panel

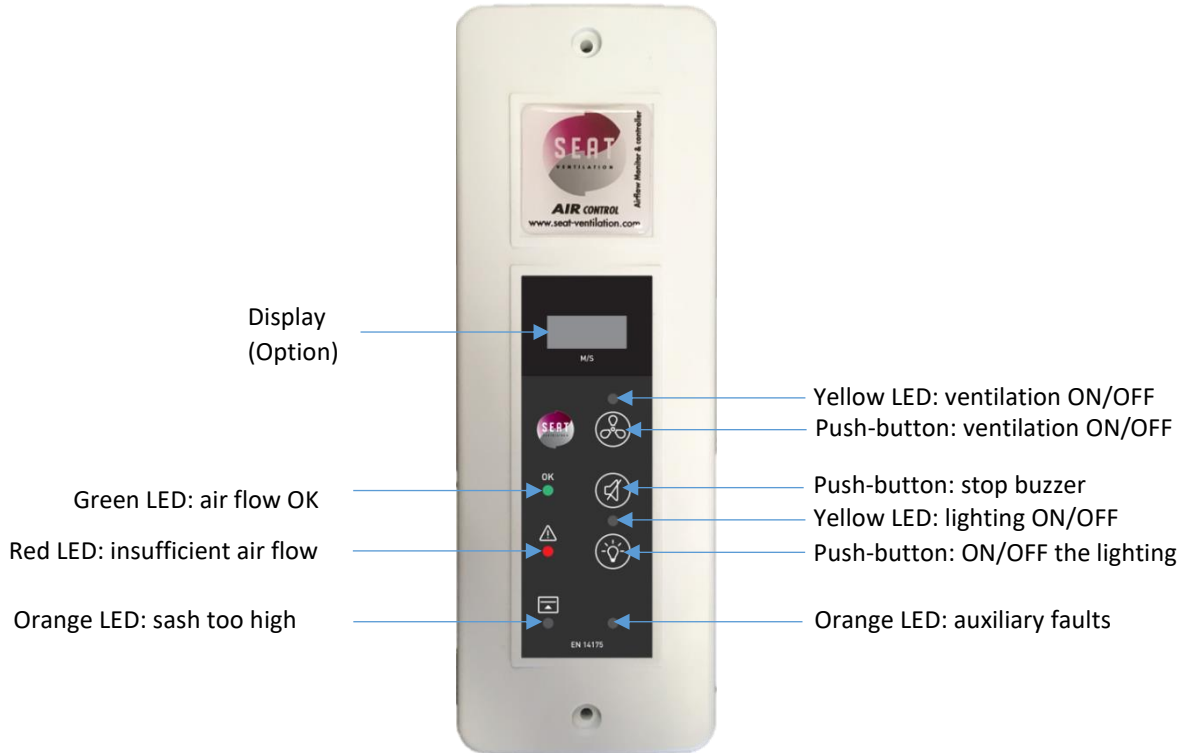

### 1.2. Electronic panel

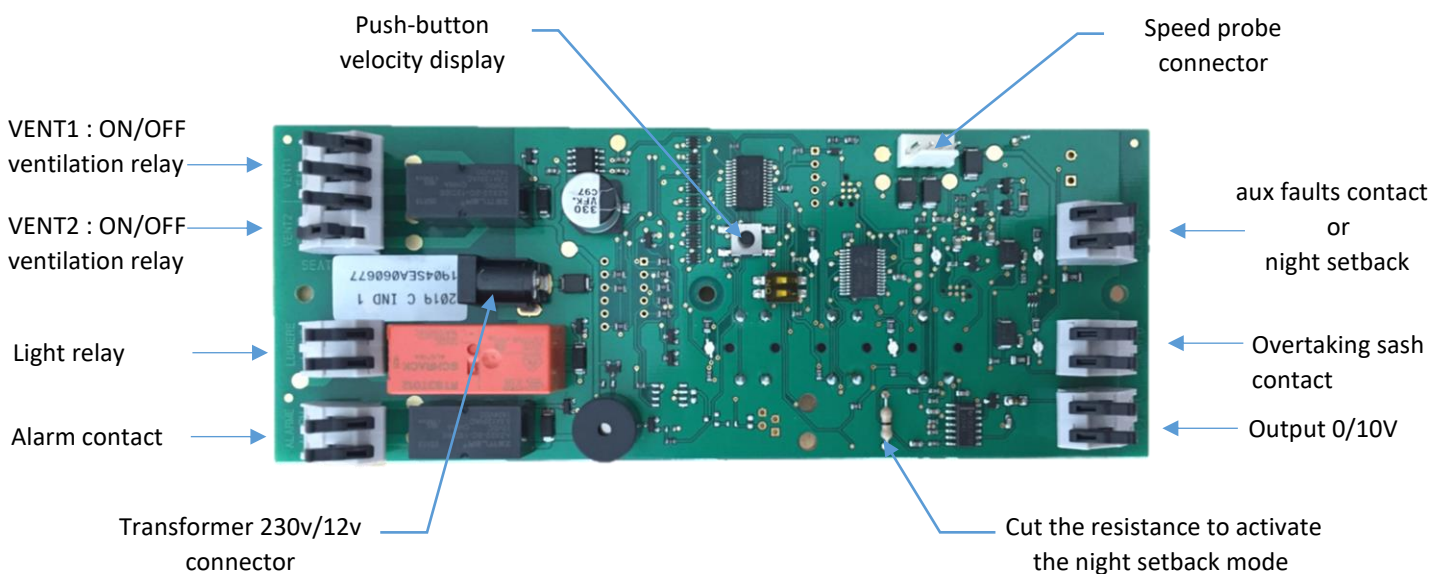

### 1.3. Schematic diagram

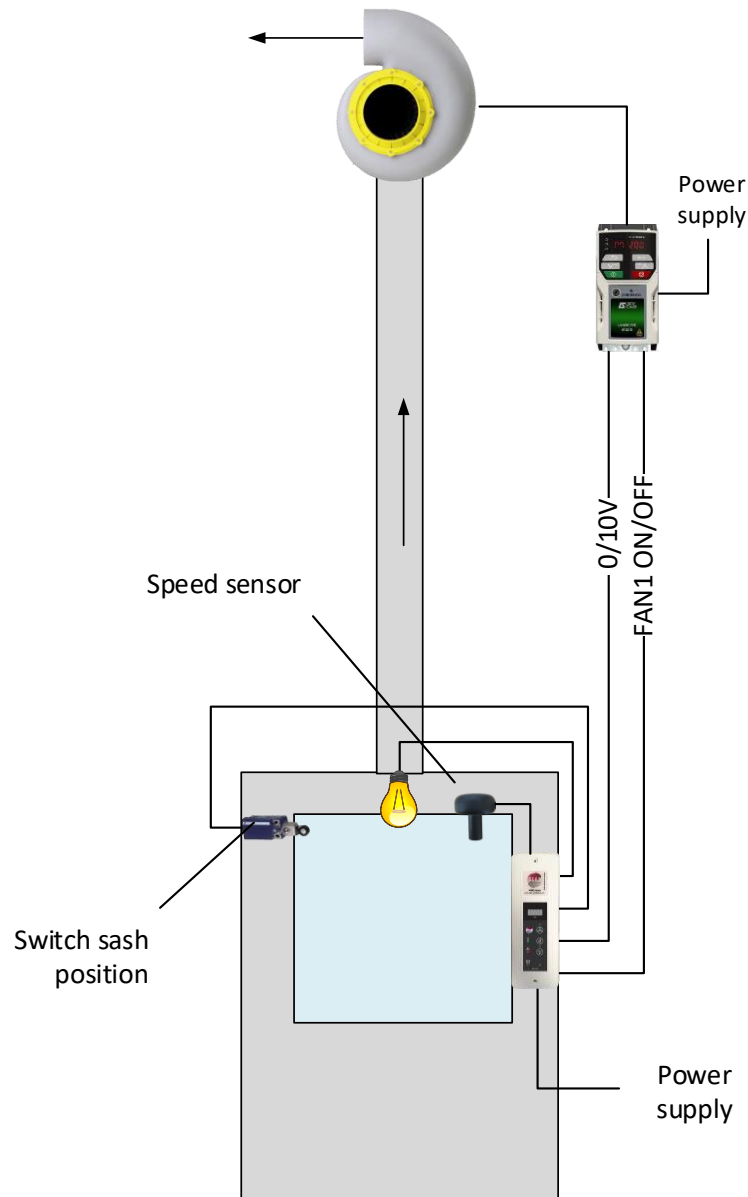

The flow controller **type C** is used to control the airflow of a fume hood.

Pressing the ventilation ON/OFF button on the controller enables the two relays VENT 1 and 2 to be closed, which unlocks the drive. The controller then sends a 0/10v signal that the drive will interpret in order to change the motor rotation speed and the flow rate. This is a **PID controller**.



A speed sensor permits to measure whether the suction flow is sufficient ( $\geq 0.4$  m/s) and indicates the ventilation status by a green and red LED.

The front panel allows you to control the operation of the fume hood and in particular:

- An ON/OFF for lighting
- An ON/OFF for ventilation
- An alarm stop button



## 1.4. Connector specifications

<b>Power supply</b>	Electrical transformer 230v/12v 500mA. (delivered with)
<b>VENT1/FAN1</b>	ON/OFF Ventilation relay driving by  Disconnection voltage: 120v Disconnection current: 0.5 A
<b>VENT2/FAN2</b>	Same VENT1
<b>0/10v</b>	0/10v output which returns a voltage according to the speed measured by the sensor. This output must be sent to the frequency inverter.
<b>LIGHT</b>	ON/OFF lighting relay driving by  Disconnection voltage: 220v Disconnection current: 3 A
<b>ALARM</b>	Relay controlled by alarm activation. Normally open contact Disconnection voltage: 120v Disconnection current: 0.5 A
<b>SASH Open</b>	Sash contact which triggers a visual and audible alarm.
<b>IDLE</b>	Auxiliary fault contact which triggers a visual and audible alarm. This contact can be used to enable night standby mode by cutting the resistance shown on page 3.



## 2. Installation and mounting

### 2.1. Dimensions

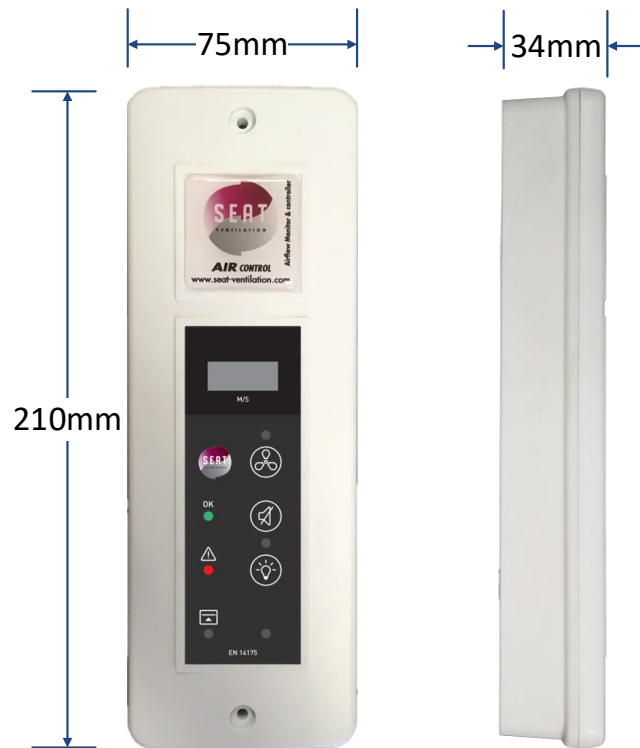

**HMI**  
**(Front and side view with surface box mounting)**

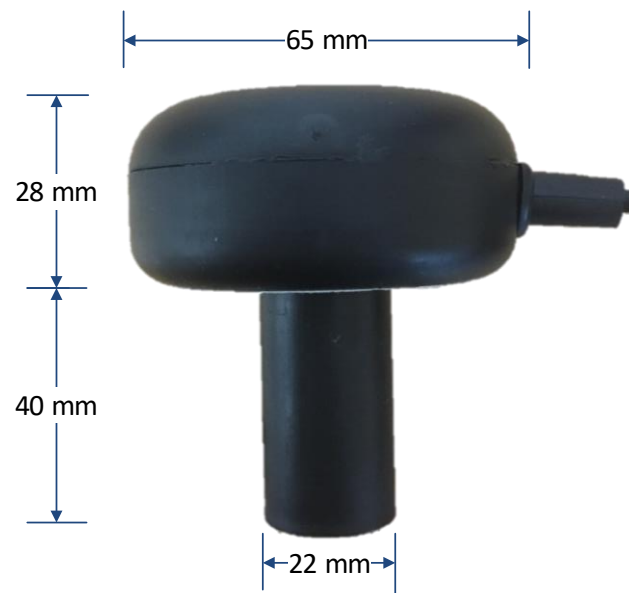

**Speed sensor**

## 2.2. Installation on the fume hood

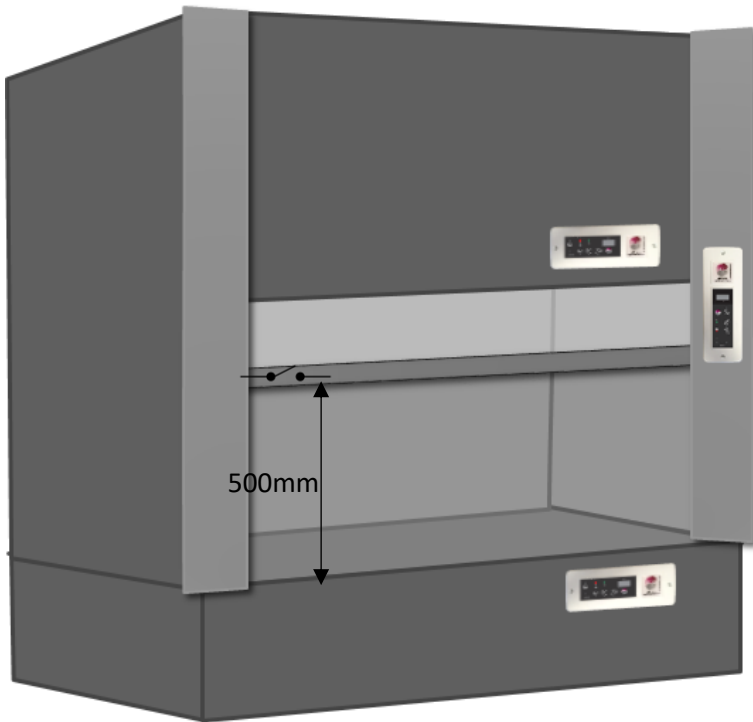

- Vertical HMI are usually attached to the side frame of fume hoods.

Horizontal HMI's can be set at the user's convenience.

- The sash contact must be fixed so that it sets off when the sash exceeds 400mm or 500mm.



To comply with EN 14175 standard, you must install a sash contact.

### Where to install the speed sensor?

The speed sensor must be positioned on the fume hood ceiling in one of the two positions shown in the diagram.

These locations must be respected so that the probe is accurate.

Drill a 22mm diameter hole and put the speed sensor in it.

An adhesive is provided on the sensor to fix it correctly to the fume hood and prevent leaks.

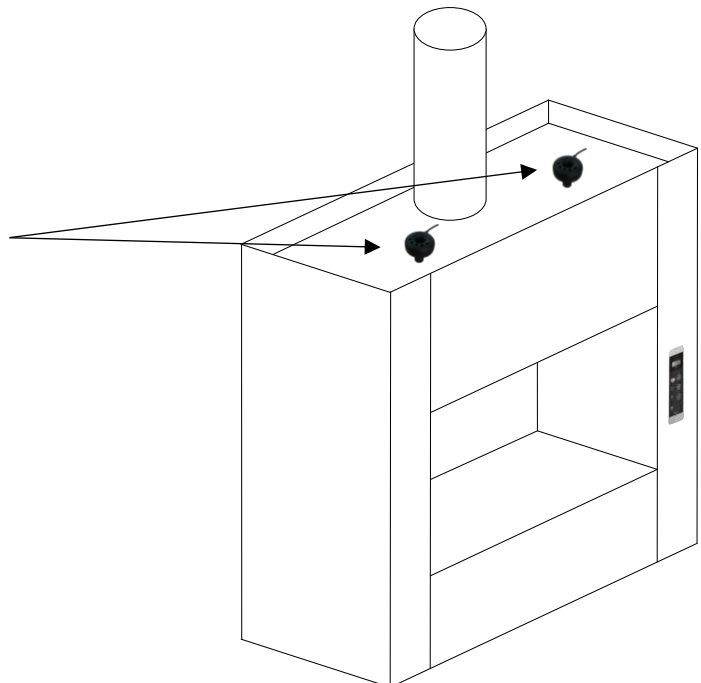

### 2.3. Cutting template

If you want to install your fume hood controller without the surface bow mounting, you will need to make the following cuts:

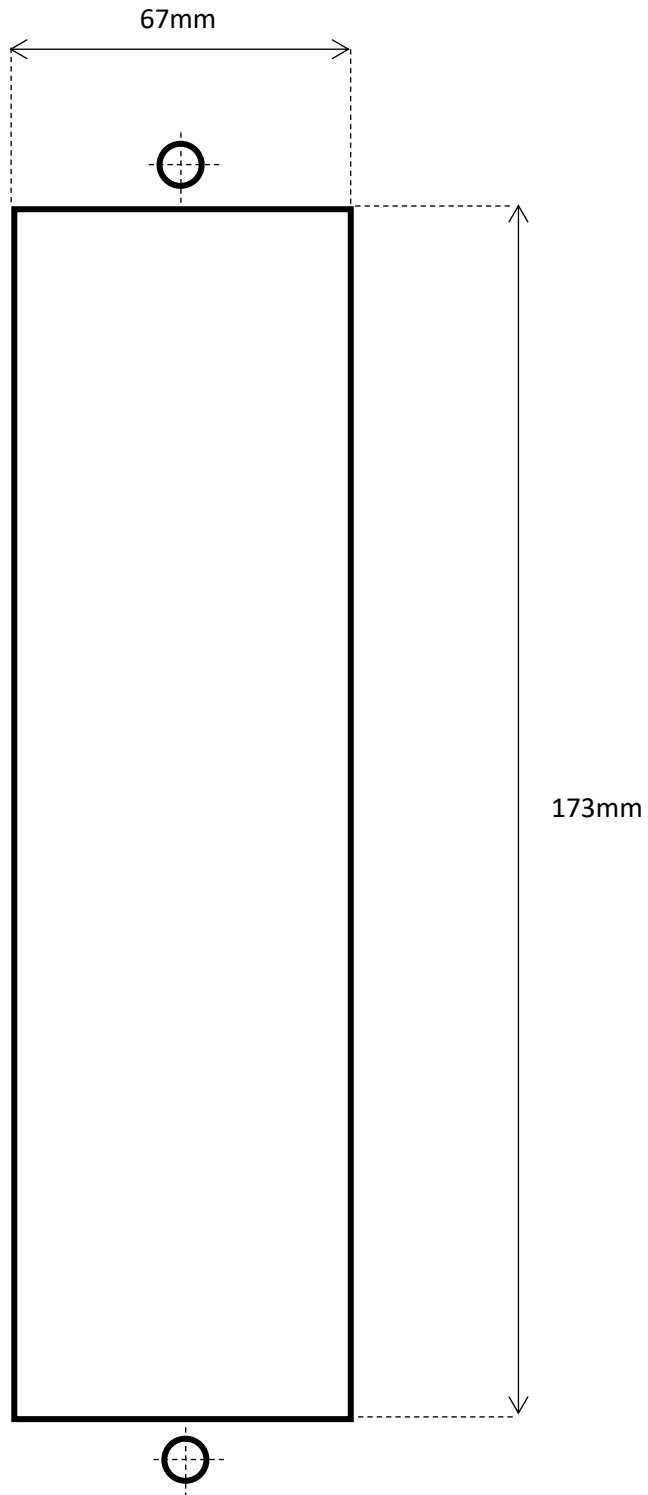



## 2.4. Installation tips

- Do not install the sensor on the extraction tube above the fume hood
- Avoid installing the sensor in a dead zone of the fume cupboard
- The probe must pass entirely through the fume cupboard ceiling. Otherwise, you must use a 25mm PVC tube to extend the outlet.
- A speed of 0.2 m/s minimum must be measured through the sensor to ensure proper operation.
- When adjusting the controllers, it is necessary that:
  - The fans are running
  - The laboratory is completely closed (doors, windows, etc.)
  - Have an anemometer
- Pay attention to motor connections (star or delta)

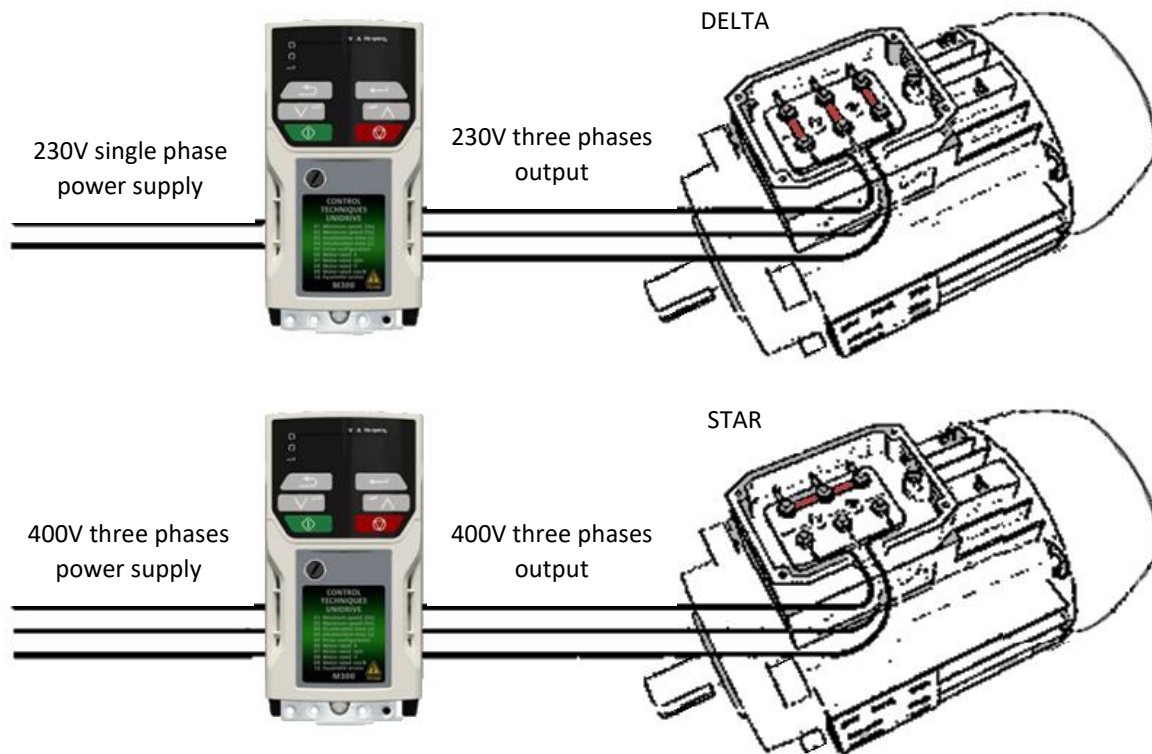

### 3. Wiring diagram

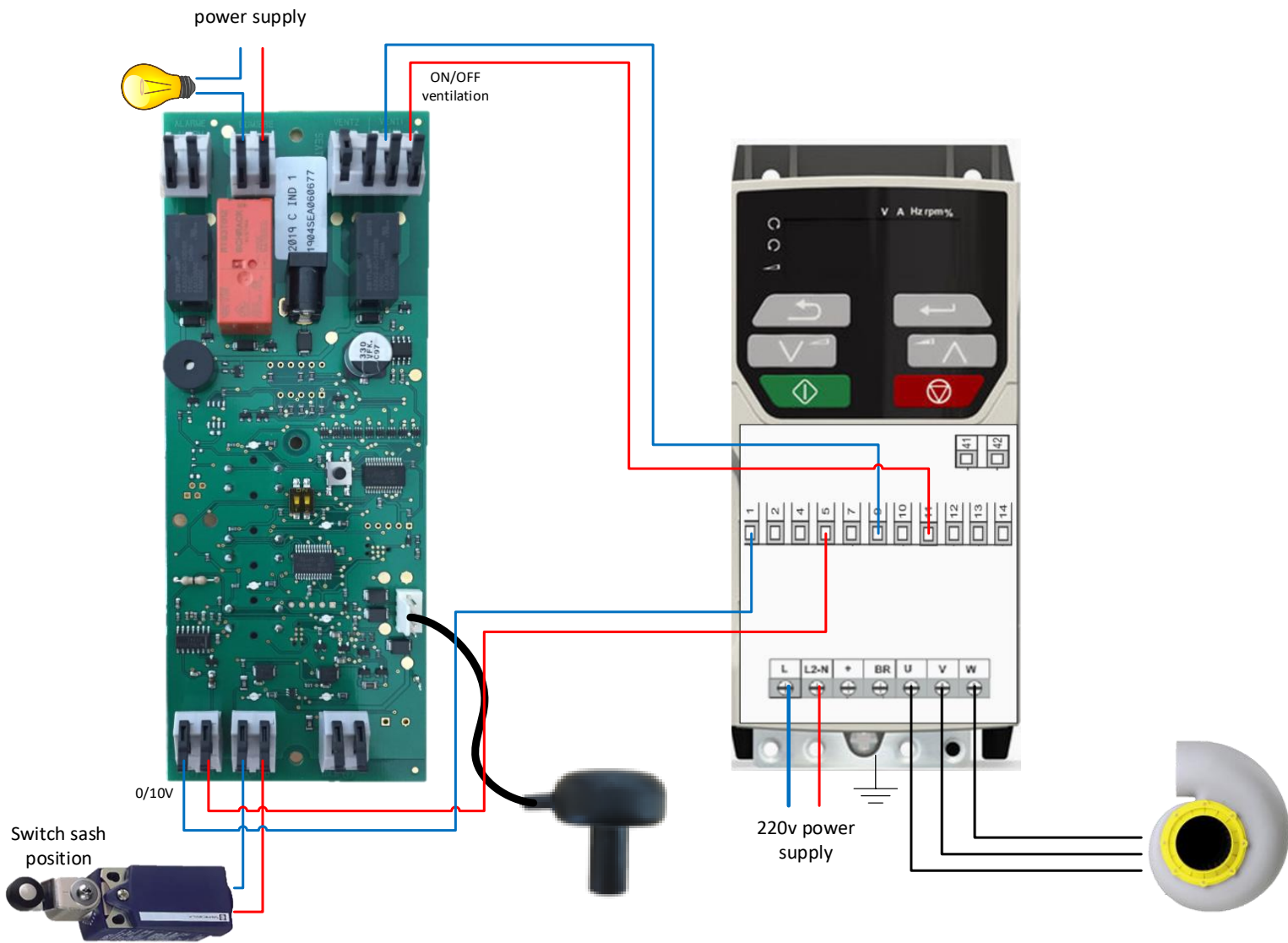

## 4. Adjustment procedure

This flow controller needs only 2 settings: a 0/10v set point setting to adjust the face velocity and a display adjustment in case you have the display option.

- 1 Switch on ventilation with
- 2 Lift up the sash in high position (400mm). Wait 15 seconds for the air speed to stabilize.
- 3 Then measure the frontal air velocity of the fume cupboard with an anemometer. The frontal velocity has to be  $\geq 0.4$  m/s
- 4 If the speed is not correct (too low or too high), **enter the setting mode:** Press 3 seconds on release and press simultaneously on and shortly. The beeper then sounds twice and the red LED flashes. You are in the setting mode. If you have the display model, the monitor will show the voltage the controller is communicating.

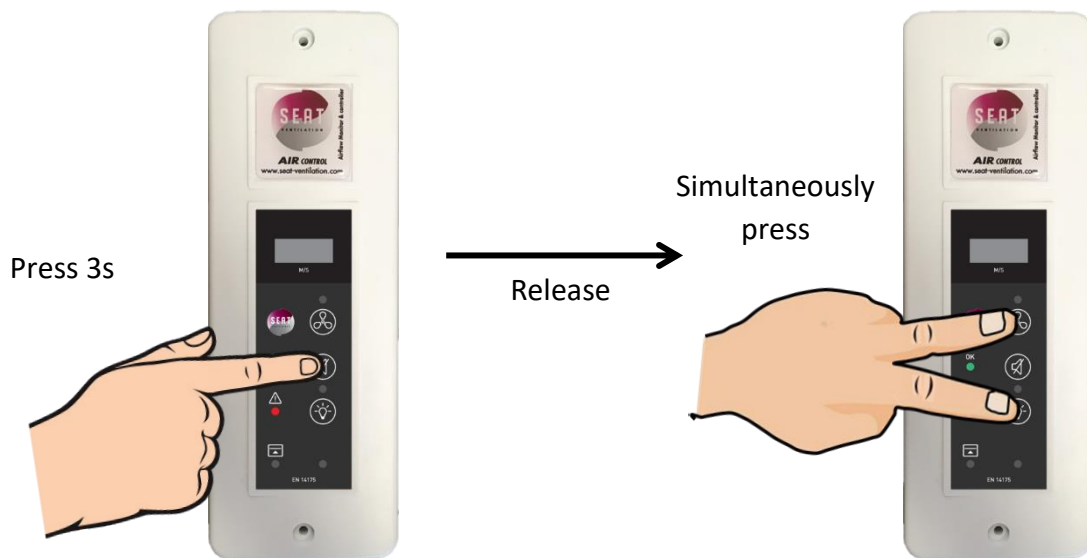
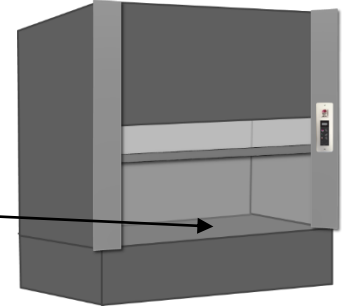

- 5 Press on to increase the speed  
Press on to decrease the speed
- Once the anemometer measures a speed  $\geq 0.4$  m/s, the 0/10v setpoint is adjusted.
- Each press increments the setpoint voltage by 0.5V over a range of 0.5V to 10V.



A press on increase the 0/10V reference sent to the drive.

A press on decrease the 0/10V reference sent to the drive.



## 6 IF DIGITAL DISPLAY MODEL

Press the push-button on the rear face to synchronize the speed reading on the anemometer and the speed displayed on the controller. One push increases by 0.1 m/s over a range of 0.3 à 0.7 m/s

7 Once the setting has been made, a long press on  allows to **both enter and exit the adjustment mode**.

The controller is now ready for use.

## 5. Factory reset

Press the push button on the electronic board for 15 seconds (the buzzer then rings 5 times to indicate that the procedure is working properly).

This procedure resets the factory settings: Setpoint and display to 0.5m/s, 7V analogue output and all relays and LEDs to off.

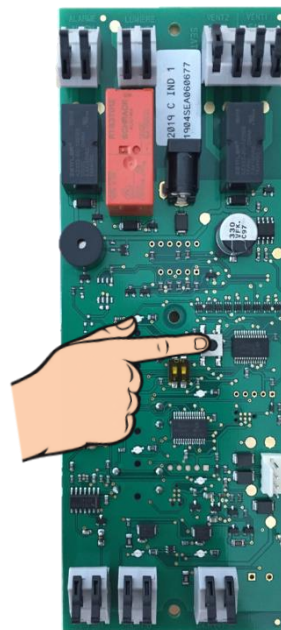

## 6. Test mode

“Test” mode confirms that all functions of the instrument are operational. To enter Test mode, Follow the procedure:

1 Press the 3 buttons simultaneously



Then the buzzer sounds twice.

2 Press the 3 buttons one after the other to check their correct operation:

- The buzzer sounds 3 times to indicate normal operation.
- The buzzer sounds 10 times if the function is faulty.

## 7. Change the audible alarm delay

It is possible on the rear face to change the buzzer's trigger time with the two switches.

- 1 = ON: Alarm still active
- 1 = OFF: Alarm disabled if ventilation is off
- 2 = ON: Delay set as 30s
- 2 = OFF: Delay set as 15s

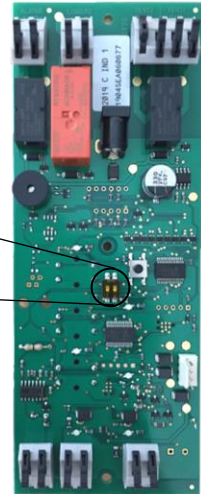
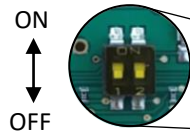

## 8. Error messages (digital display option)

The controller displays « **HI** » for a frontal speed greater than 0.8 m/s.  
The controller displays « **LO** » for a frontal speed lower than 0.2 m/s.  
The controller displays « **PB** » in case of speed sensor problem.



## 9. FAQ

Questions	Solutions
<b>No indicators</b>	Check that the power supply is correctly connected.
<b>The fan does not start up</b>	Check that the controllers ON button is fully engaged and that the yellow light above is on. Check wiring.
<b>The display shows "PB"</b>	Check that the speed sensor is correctly connected to the controller. Turn off and then restore power to the controller.
<b>The light does not illuminate</b>	The controller does not provide power, it provides a normally open contact. The light must be connected in the same way as if it were controlled by a switch.
<b>The frontal speed is too low</b>	Check the direction of rotation of the motor. Check that the system of installation is correct.
<b>Front speed is too high</b>	Check that the sizing of the installation is correct.
<b>The display shows "8.8.8"</b>	You are in Test mode: see the settings on page 12 to exit this mode.
<b>The green LED is on and the red LED is flashing</b>	You are in setting mode: see pages 11-12 to exit this mode.
<b>The alarm sounds after a short time</b>	Change the alarm delay with the CPU switches: see at the top of this page.
<b>The speed does not change</b>	Check with a voltmeter if the 0/10v output varies: <ul style="list-style-type: none"> <li>- If it changes, check the drive connections.</li> <li>- If it does not change, check the correct positioning of the probe on the fume cupboard and carry out the adjustment procedure.</li> </ul>



## 10. Maintenance

- Do not use abrasive materials.
- Avoid splashing liquid on the plastic box.
- Do not install the sensor on the extraction tube above the fume hood.
- Do not install the sensor in a dead zone of the fume hood.
- The sensor must not be subjected to air flow disturbances.
- The sensor must lead to the laboratory pressure.
- When setting up the controller, it is necessary that:
  - The fan is running
  - The lab must be completely closed (doors, windows, etc.)
  - Have an anemometer

## 11. Warranty

SEAT Ventilation guarantees that its equipment, products and parts are free from manufacturing defects under normal conditions of use for a period of two years after delivery to the first user. If a factory return is required within the two-year period from the date of purchase, contact your distributor. Products must be returned to the point of purchase with a dated invoice.



SEAT VENTILATION SAS  
PARC TECHNOLOGIQUE DELTA SUD  
09340 VERNIOLLE  
France  
E-mail: [info@seat-ventilation.com](mailto:info@seat-ventilation.com)  
Site Web: [www.seat-ventilation.com](http://www.seat-ventilation.com)

